

## Pressure transmitter PASCAL Ci4

with threaded connection

Type series CI410.



### Application area

- Machinery construction
- Chemical and petrochemical industry
- General process technology

### Application

The digital pressure transmitter PASCAL Ci4 is suitable for measuring the relative and absolute pressure of gases, vapors and liquids. Due to the design the transmitter is suitable for highest requirements. The 4 operation buttons allow an easy and fast parameterisation.

Especially for use in hydrogen applications a calculation tool is available with which the suitable sensor diaphragm material (with/without gold plating) can be determined on the basis of the available process data.

### Features

- Pressure transmitter for the measuring of relative and absolute pressures of gases, vapors and liquids
- Stainless steel case in sturdy design, degree of protection IP 65/67
- Accuracy  $\leq 0.1\%$
- High-resolution graphic display with Intuitive 4-button operation and backlight
- Comprehensive parameterising functions
- Comprehensive simulation and diagnostic functions
- Quick access to device data
- Development according to SIL2
- Nominal range 0.25 bar to 400 bar
- Turndown up to 100:1
- Measuring rate up to 100 Hz
- Output signal 4...20 mA with HART® protocol
- Configuration memory
- Digital communication via PDM/EDD, FDT/DTM, 375/475 Field Communicator
- Output functions: linear, invers, square root, table function with up to 64 support points
- Media temperature  $-40...100\text{ }^{\circ}\text{C}$
- Wetted parts stainless steel
- Case design:
  - process connection bottom
  - process connection at back
- Process connections: various screw-in thread with internal diaphragm
- Approved according to NAMUR 95

### Options

- Accuracy  $\leq 0.075\%$
- Gold coating of sensor diaphragm (thickness 6  $\mu\text{m}$ )
- Approvals/Certificates
  - Explosion protection (ATEX/IECEx/UKEX) for gases and dust
  - Classification per SIL2
  - Material certificate per EN 10204-3.1
  - Calibration certificate per EN 10204-3.1
  - Certificate for hydrogen resistance per EN 10204-3.1
- As per UKCA regulations
- Operating software LAB4Level for level measurements
- Removable display and control unit
- Degree of protection IP 69K

## Technical data

### Measuring ranges

Up to a turndown of 100:1 the measuring span can be freely selected.

Nominal range	Measuring span		Overload capacity	Higher overload (option)	Lower measuring range limit **	Sensor type
	min	max				
0...1 bar *	0.01 bar	2 bar	3 bar	-	100 mbar abs	Piezoresistive
0...4 bar *	0.04 bar	5 bar	10 bar	-	100 mbar abs	
0...16 bar *	0.16 bar	17 bar	60 bar	-	100 mbar abs	
0...40 bar *	0.4 bar	41 bar	100 bar	-	100 mbar abs	
0...100 bar *	1 bar	101 bar	200 bar	-	100 mbar abs	
-0.25...0.25 bar	0.0025 bar	0.5 bar	1 bar	6 bar	750 mbar abs	
-1...1 bar	0.01 bar	2 bar	3 bar	10 bar	30 mbar abs	
-1...4 bar	0.04 bar	5 bar	10 bar	25 bar	30 mbar abs	
-1...16 bar	0.16 bar	17 bar	60 bar	120 bar	30 mbar abs	
-1...40 bar	0.4 bar	41 bar	100 bar	120 bar	30 mbar abs	
-1...100 bar	1 bar	101 bar	200 bar	-	30 mbar abs	
-1...400 bar	4 bar	401 bar	750 bar	-	30 mbar abs	Thin film
-1...600 bar	6 bar	601 bar	800 bar	-	30 mbar abs	
0...1 bar abs	0.01 bar abs.	1 bar abs.	3 bar abs.	-	30 mbar abs	Piezoresistive
0...4 bar abs	0.04 bar abs.	4 bar abs.	10 bar abs.	-	30 mbar abs	
0...16 bar abs	0.16 bar abs.	16 bar abs.	60 bar abs.	-	30 mbar abs	

\* Short term or sporadic measurement in vacuum range permitted up to lower measuring limit. Lower range value up to -1 bar rel. adjustable.

\*\* Vacuum-proof designs are available upon request.

### Constructional design / case

Design: Two-chamber case, continuously rotatable by  $\pm 170^\circ$   
Case surface blasted

Material case:   

- Stainless steel mat.no. 1.4301/1.4305 (304/303)
- Stainless steel mat.no. 1.4404 (316L)

Material front cover:   

- Stainless steel mat.no. 1.4305 (303)
- Stainless steel mat.no. 1.4404 (316L)
- Polypropylene, black

Gaskets: Silicone / NBR

Degree of protection per EN 60529: IP 65 / IP 67  
Option: IP 69K

Climatic category: 4K4H per EN 60721 3-4

Vibration resistance per EN 61298-3: 10...60 Hz:  $\pm 0.35$  mm  
60...1000 Hz: 5 g

Material window:   

- Macrolon
- Non-splintering glass (requires front cover of stainless steel)

Elec. connection:

- Circular connector M12
- Cable gland M16x1.5, PA black
- Cable gland M16x1.5, stainless steel
- Cable gland M20x1.5, PA black
- Cable gland M20x1.5, stainless steel
- 1/2" NPT, PA black

Further connections upon request

Terminal blocks:

- Spring clamp terminals up to 1.5 mm<sup>2</sup>
- Pole terminals up to 2.5 mm<sup>2</sup>
- Screw terminals up to 2.5 mm<sup>2</sup>

Weight:

Approx. 1.4 kg

Type plate:

Laser marking

### Process connection

Position:

- bottom
- back \*

\* Flush mounting upon request

Design:

- G 1/2 B per DIN EN 837-1
- G 1/4 B per DIN EN 837-1
- G1/4 A per DIN EN ISO 1179-2 (DIN 3852-11) model E
- 1/2 " NPT
- 1/4 " NPT

Further process connections upon request

## Material wetted parts

Sensor:	Piezoresistive	Thin film
Sensor diaphragm:	1.4404/1.4435 (316L) optional: gold-coated (6 µm)	1.4542 (630)
Socket:	1.4404/1.4435 (316L)	1.4301/1.4404 (304/316L)

## Measuring system

Sensor:	Piezoresistive	Thin film
Sensor filling:	Synthetic oil, free of silicone FD1, FDA listed	Without

## Measuring accuracy

Reference cond. per EN 61298-1:	$T_U = \text{const. (15...25) } ^\circ\text{C}$ $\varphi = \text{const. (45...75) \% r.F.}$ $p_U = \text{const. (860...1060) mbar}$ $U_B = 24 \text{ V DC } (\pm 3 \text{ V DC})$ $R_B = 50 \text{ } \Omega$ , HART: 250 $\Omega$ Ground connected MBA = 0 bar
Calibration position:	Process connection bottom: vertical Process connection back: horizontal

Reference accuracy:

Per EN 60770 incl. non-linearity, hysteresis and repeatability refer to the adjusted measuring span:

Nominal range	Turndown $\leq 5:1$	Turndown $> 5:1$
1 - 400 bar	$\leq \pm 0.1 \%$	$\leq \pm 0.02 \% \times \text{TD}$
0.25 bar	$\leq \pm 0.15 \%$	$\leq \pm 0.03 \% \times \text{TD}$
Nominal range	Turndown $\leq 3,75:1$	Turndown $> 3,75:1$
1 - 40 bar	$\leq \pm 0.075 \%$	$\leq \pm 0.02 \% \times \text{TD}$

Long-term drift:	Refer to nominal range $\leq 0.1 \%$ /year
Operational availability:	$< 12 \text{ s}$
Response time $t_{90}$ at current output:	for 20 Hz measuring rate: typ. 120 ms for 100 Hz measuring rate: typ. 50 ms

Temperature influence, case:

Refer to nominal range		
Nominal range	temp. -20...80 °C	temp. -40...+20 °C
1 - 400 bar	$\leq \pm 0.1 \%/10\text{K}$ , max. 0.3 %	typical $\leq \pm 0.2 \%/10\text{K}$
0.25 bar	$\leq \pm 0.15 \%/10\text{K}$ , max. 0.4 %	

## Indication

Display:	- High-resolution graphic display with backlight - 4-button operation - Freely configurable display modes - continuously rotatable - Optional: Remote display and control unit (max. 10 m)
----------	--

Configuration memory: All parameterisation data can be copied from the device into the configuration memory in the display module. The data is permanently stored there, even in the event of power failure.

The parameters can be transferred simply and quickly to other devices.

## Output

Signal:	2-wire technology	4...20 mA
	Lower limit	3.8...4 mA
	Upper limit	20...21 mA
	Lower alarm current	$< 3.6 \text{ mA}$
	Upper alarm current	$> 21 \text{ mA}$
	Current limitation	22 mA
Digital communication:	HART ® protocol, version 7	

Device driver:

- EDD für SIMATIC PDM
- DTM for PACTware or compatible systems (FDT compliance)
- EDD for 375 / 475 Field Communicator

Function:	<ul style="list-style-type: none"> <li>■ linear</li> <li>■ inverse response</li> <li>■ by square root</li> <li>■ table function with up to 64 support points</li> </ul>
-----------	---

Turndown:	Max. 100:1
Damping:	0...999.9 s selectable in steps of 0.1 s
Measuring rate:	20 Hz, switchable to 100 Hz
Resolution:	0.5 µA
Current sensing func.	3.55...21.5 mA selectable in steps of 0.001 mA
Load R:	$R \leq (U-12\text{V DC})/0.022 \text{ A } [\Omega]$ U = supply voltage for HART ® communication $R \geq 230 \text{ } \Omega$

## Supply voltage

Functional range:	12...30 V DC, protected against polarity reversal
Ripple:	$< 5 \%$

## Temperature ranges

Ambient:	-40...80 °C (Display visibility is limited at temperatures below - 30 °C)
Media:	-40...100 ° C
Storage:	-40...80 °C

## Tests and certificates

### Ex approvals

ATEX:	TÜV 13 ATEX 120264 X ⊕ II 1/2G Ex ia IIC TX Ga/Gb ⊕ II 1/2D Ex ia IIIC Txx °C Da/Db ⊕ II 2G Ex ia IIC TX Gb ⊕ II 2D Ex ia IIIC Txx °C Db
IECEX:	IECEX TUN 13.0018X Ex ia IIC TX Ga/Gb Ex ia IIIC Txx °C Da/Db Ex ia IIC TX Gb Ex ia IIIC Txx °C Db
UKEX:	CML 21UKEX21179X ⊕ II 1/2G Ex ia IIC TX Ga/Gb ⊕ II 1/2D Ex ia IIIC Txx °C Da/Db ⊕ II 2G Ex ia IIC TX Gb ⊕ II 2D Ex ia IIIC Txx °C Db

Detailed information can be found in the Ex instructions XA\_010 and XA\_011 (depending on the Ex versions, see order details).

EMC *:	Per DIN EN 61326-1, NAMUR NE21 * A deviation of accuracy due to EMC influence up to 0.25 % is impossible for a design with process connection at the back.
SIL 2:	Functional safety per EN 61508, classification per SIL2 For detailed information see SIL instruction SA_001
NAMUR:	Approved according to NE95, Test report TP14033 available upon request

- Certificate for hydrogen resistance per EN 10204-3.1

## Parameterisation, simulation and adjustment

### Parameterisation

Parameter	Values	Default setting
<b>Device</b>		
device ID	16 digits, freely selectable	LABOM PASCAL Ci4
lower range value	at any value within nominal range	0 bar respectively 0 bar abs.
upper range value	at any value within nominal range	end of nominal range
measuring rate	20 Hz, 100 Hz	20 Hz
damping	0.0...999.9 s	0.0 s
<b>Display and control unit</b>		
pressure unit	mbar, bar, Pa, hPa, kPa, MPa, g/cm <sup>2</sup> , kg/cm <sup>2</sup> , psi, atm, Torr, mmH <sub>2</sub> O, mH <sub>2</sub> O, inH <sub>2</sub> O, ftH <sub>2</sub> O, mmHg, inHg	bar
temperature unit	°C, °F, °R, K	°C
lighting	on, off	on
language	English, German	German
	English, Chinese	as ordered
	English, Spanish, French	as ordered
	English, Polish, German	as ordered
	English, Turkish, German	as ordered
decimal point	auto, x.xxxx, xx.xxx, xxx.xx, xxxx.x, xxxxx	auto
display mode	five values, four values, three values, two values, big display	four values
main value	pressure, current (%), current (mA)	pressure
secondary values	pressure, current (%), current (mA), sensor temperature, device ID, HART-TAG, HART descriptor, <empty>	current (%), current (mA), device ID
<b>Current output</b>		
output function	linear, inverse response, by square root, table function	linear
table function	% of m.r., output current	depends on device
number of table points	2...64	2 (0 % ≙ 4 mA, 100 % ≙ 20 mA)
lower current limit	3.8...4.0 mA	3.8 mA
upper current limit	20...21 mA	20.5 mA
alarm current	low (<3.6 mA), high (> 21.0 mA)	low (<3.6 mA)
position correction (mounting position)	on, off	off
<b>Maintenance counter</b>		
maintenance interval	0...9999 days	0 days
status	on, off	off
<b>HART data</b>		
HART address	0...63	0
number of response preambels	5...20	5
current mode	proportional, constant	proportional

### Diagnostic functions

Self- diagnosis	Description	Value range
RAM-Test	Permanent check of the read/write memory	/
ROM-Test	Permanent check of the checksum via the program memory	/
Bridge circuit test	Permanent check of the bridge circuit	/
CRC parameterisation test	Permanent check of the checksum via the parameter memory	/
Electronics temperature monitoring	Permanent check of the electronics temperature	/
<b>Process diagnostics</b>		
Maintenance timer	Check of the maintenance cycles	/
Operating hours counter	Capture of operating hours	/
Min/Max values	For process pressure and sensor temperature	/
<b>Measuring circuit diagnostics</b>		
loop-test	Setting of a fixed current value at the output	3.55...21.5 mA
pressure simulation	Setting a fixed pressure value, it also considers damping and tabular function unlike the current simulation	Nominal range

## Adjustment

Type	Description
zero point correction	adjusts reading to zero at ambient pressure (for differential and gauge pressure devices)
position correction	adjusts reading of mounted device to zero at ambient pressure
lower adjustment	adjusts reading to applied pressure (affects zero point + span)
upper adjustment	adjusts reading to applied pressure (affects span only)
current adjustment	adjusts current output to achieve 4 resp. 20 mA at the end of the measurement chain

## Alternative and additional possibilities of parameterisation for devices with level software LAB4Level

Parameter	Values	Default setting
<b>Display and control unit</b>		
filling height unit	mm, cm, m, ft, in, yd	m
volume unit	l, hl, m <sup>3</sup> , in <sup>3</sup> , ft <sup>3</sup> , gal	l
weight unit (mass)	g, kg, t, lb	kg
density unit	g/cm <sup>3</sup> , kg/cm <sup>3</sup> , t/m <sup>3</sup> , kg/l, lb/in <sup>3</sup> , lb/ft <sup>3</sup>	g/cm <sup>3</sup>
display mode	level 4 values, level 2 values, five values, four values, three values, two values, big display	level 4 values
main value	filling height, volume, weight, pressure, current in %, current in mA	filling height
secondary values	filling height, volumen, weight, pressure, static pressure, current in %, current in mA, sensor temperature, density, device ID, HART-TAG, HART-Descriptor, <leer>	current in %, current in mA, device ID
<b>Level</b>		
density	0.1...20 g/cm <sup>3</sup>	1 g/cm <sup>3</sup>
offset height	max 99.999 m	0 m
tank shape table	on/off	off (= linear)
table function	64 support points (filling heights/volume)	
<b>Current output</b>		
measured value	height, volume, weight, pressure (equal 4...20 mA)	height
number of table points	0 / 2...64	0

## Diagnostic functions

Measuring circuit diagnostics		
simulation function	pressure, filling height, volume, weight (mass), current	/
min/max values	for process pressure, sensor temperature, filling height, volume and weight	/

## Connection diagram

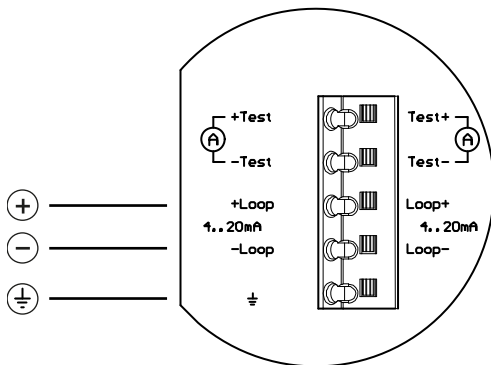

Cable gland

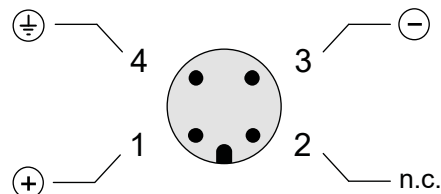

Circular connector M12 x 1

# Dimensions

## Case

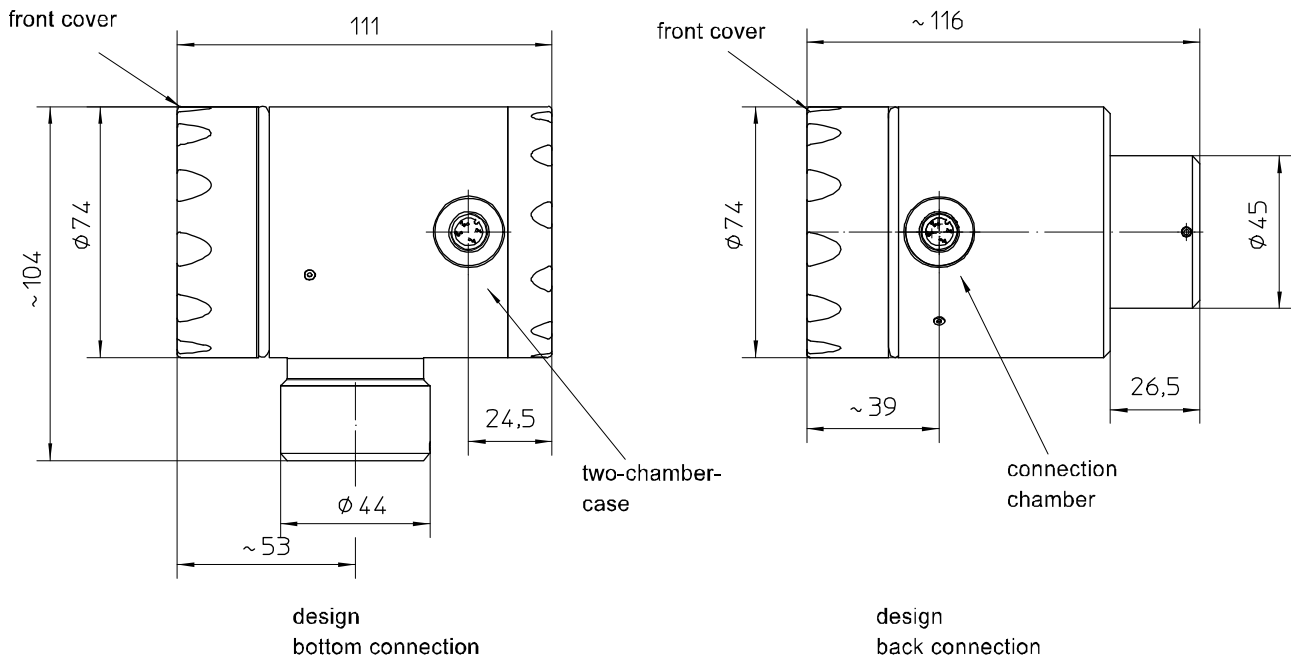

## Electrical connections

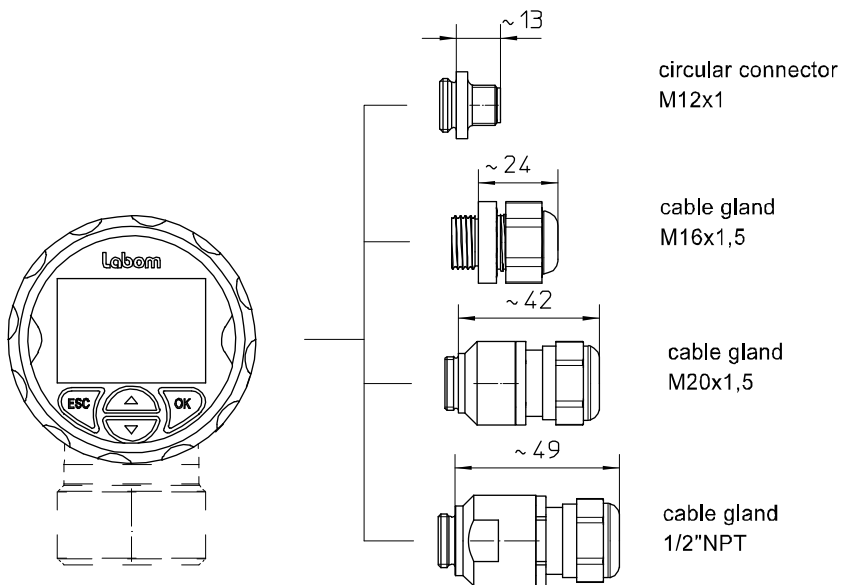

All dimensions are in mm

## Process connections

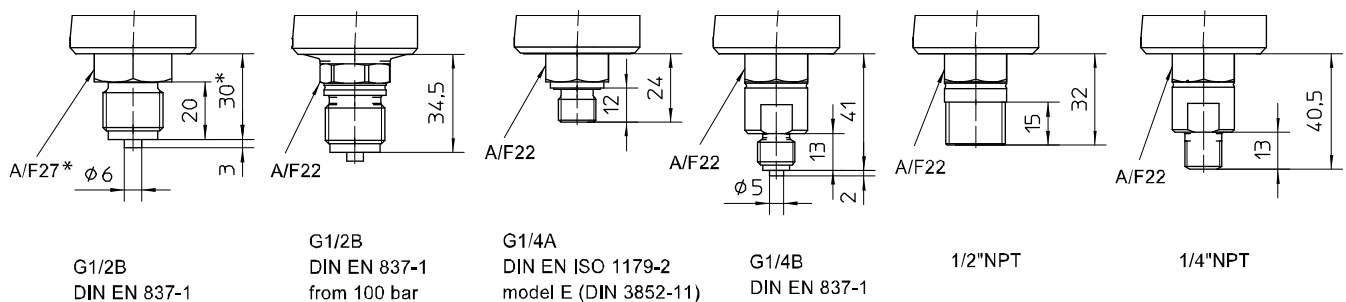

\* Deviations possible due to design

All dimensions are in millimeters

## Remote display and control unit (Type series MC1140)

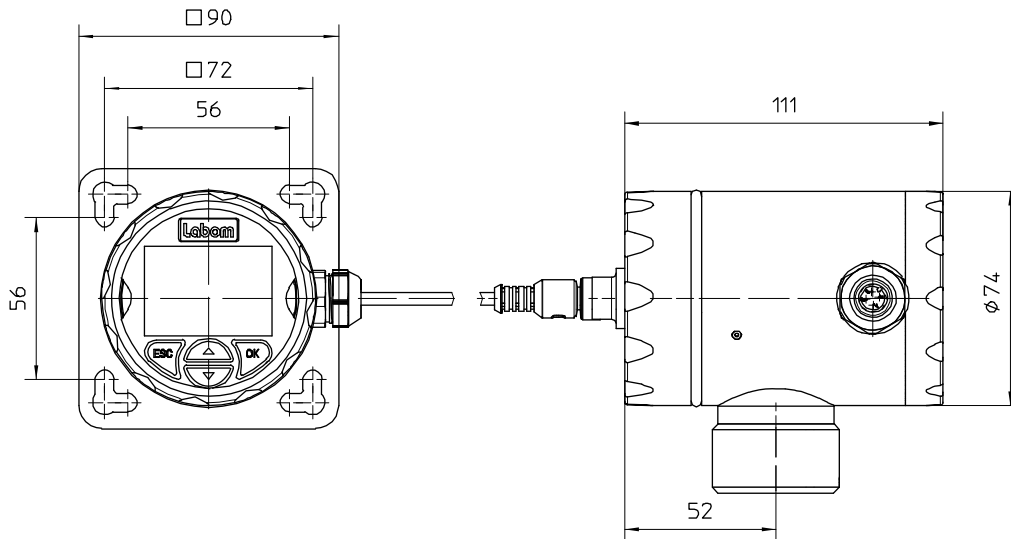

All dimensions are in mm











## Order details

### Pressure transmitter PASCAL Ci4 with threaded connection Type series CI4100

Order details PASCAL CI410.									
Pressure transmitter PASCAL Ci4 with threaded connection									
CI4100	process connection bottom								
CI4103	process connection back								
	nominal range	turndown	overload limit [bar]	higher overload limit [bar]	Ex marking (see below)	sensor type			
A1053	0...1 bar	TD up to 100:1	3	-	S66 / S76 / S86	piezoresistive			
A1056	0...4 bar		10	-	S66 / S76 / S86				
A1059	0...16 bar		60	-	S66 / S76 / S86				
A1061	0...40 bar		100	-	S66 / S76 / S86				
A1063	0...100 bar		200	-	S62 / S77 / S87				
A1178	-0,25...0,25 bar		1	-	S66 / S76 / S86				
A1153	-1...1 bar		3	-	S62 / S77 / S87				
A1156	-1...4 bar		10	-	S62 / S77 / S87				
A1159	-1...16 bar		60	-	S62 / S77 / S87				
A1161	-1...40 bar		100	-	S62 / S77 / S87				
A1163	-1...100 bar		200	-	S62 / S77 / S87				
A1178.1	-0.25...0.25 bar		-	6	S62 / S77 / S87				
A1153.1	-1...1 bar		-	10	S62 / S77 / S87				
A1156.1	-1...4 bar		-	25	S62 / S77 / S87				
A1159.1	-1...16 bar		-	120	S62 / S77 / S87				
A1161.1	-1...40 bar		-	120	S62 / S77 / S87				
A3163	-1...100 bar		200	-	S66 / S76 / S86	thin film			
A3166	-1...400 bar		750	-	S66 / S76 / S86	thin film			
B1053	0...1 bar abs		3	-	S66 / S76 / S86	piezoresistive			
B1056	0...4 bar abs		10	-	S66 / S76 / S86				
B1059	0...16 bar abs	60	-	S66 / S76 / S86					
F1	parameterisation	factory settings (standard)							
F2		as per customer's specification (pls. specify)							
H21	output signal	4...20 mA, with HART protocol							
Y1.	material case	stainless steel mat.-no. 1.4301 (304)							
Y2.		stainless steel mat.-no. 1.4404 (316)							
1	material front cover	polypropylene (black), window Macrolon							
2		stainless steel like case, window non splintering glass							
3		stainless steel like case, closed, without window							
				default language	available language				
M21.1	display	High-resolution graphic display with backlight, intuitive 4-button operation, quick access to device data		German (standard)	English, German				
M22.1				English					
M22.2				Chinese	English, Chinese				
M23.1				English					
M23.2				Spanish	English, Spanish, French				
M23.3				French					
M25.1				English	English, Polish, German				
M25.2				Polish					
M25.3				German					
M26.1				English	English, Turkish, German				
M26.2				Turkish					
M26.3				German					
M1					without display				

T20.	electrical connection	cable gland	M16 x 1.5 polyamide, for cable Ø 4.5-10 mm
T22.			M16 x 1.5 stainless steel mat.-no. 1.4404 (316L), for cable Ø 5-9 mm
T15.			M20 x 1.5 polyamide, for cable Ø 7-13 mm
T17.			M20 x 1.5 stainless steel mat.-no. 1.4404 (316L), for cable Ø 8-13 mm
T27.			1/2" NPT polyamide, for cable Ø 6-12 mm
0		cable clamps	spring clamp terminals up to 1.5 mm <sup>2</sup>
5			pole terminals 2.5 mm <sup>2</sup>
6	screwed terminals 2.5 mm <sup>2</sup>		
T30		circular connector M12 x 1 (4 pin)	
K1010	process connection	G1/2 B per DIN EN 837-1	
K1002		G1/4 B per DIN EN 837-1	
K1024		G1/4 A per DIN EN ISO 1179-2 (DIN 3852-11) model E	
K1070		1/2" NPT	
K1072		1/4" NPT	
K9999		as per indication	

Additional features (to be indicated if required)			
J304	coating	gold coating of internal sensor diaphragm (thickness 6 µm), for hydrogen applications <sup>1</sup>	
Q11	accuracy	≤ 0.075 <sup>2</sup>	
S66	Ex marking <sup>3</sup> (Details see Ex Instruction XA_010)	ATEX	 II 1/2G, II 2G Ex ia IIC TX Ga/Gb, Gb
			 II 1/2D, II 2D Ex ia IIIC Txx°C Da/Db, Db
S76		IECEX	Ex ia IIC TX Ga/Gb, Gb
			Ex ia IIIC Txx°C Da/Db, Db
S86		UKEX	 II 1/2G, II 2G Ex ia IIC TX Ga/Gb, Gb
			 II 1/2D, II 2D Ex ia IIIC Txx°C Da/Db, Db
S62	ATEX	 II 1/2G, II 2G Ex ia IIC TX Ga/Gb, Gb	
		 II 1/2D, II 2D Ex ia IIIC Txx°C Da/Db, Db	
S77	IECEX	Ex ia IIC TX Ga/Gb, Gb	
		Ex ia IIIC Txx°C Da/Db, Db	
S87	UKEX	 II 1/2G, II 2G Ex ia IIC TX Ga/Gb, Gb	
		 II 1/2D, II 2D Ex ia IIIC Txx°C Da/Db, Db	
T4	degree of protection	IP 69K <sup>3</sup>	
X4	operating software	LAB4Level for level applications	
W1020	material certificate	per EN 10204-3.1, wetted parts <sup>4</sup>	
W1201	calibration certificate	per EN 10204-3.1, 5 measuring points	
W1251	certificate	per EN 10204-3.1, for hydrogen applications	
W2602	functional safety per EN 61508, classification per SIL2		
W2660	as per UKCA regulations		

Accessories			
MC1140	PASCAL Ci4 remote display and control unit including wall bracket		
	material stainless steel, incl. front ring with seal and blind cap with circular connector M12x1		
A1.	connection cable	length: 10 m, material: PUR, with circular connector M12 x1 (further lengths upon request)	
1	Internal cable clamps	spring clamp terminals up to 1.5 mm <sup>2</sup>	
2		pole terminals 2.5 mm <sup>2</sup>	
3		screwed terminals 2.5 mm <sup>2</sup>	
T1	degree of protection	IP 65 / IP 67 (standard)	
MZ8120-A11	mounting set for wall bracket	2 mounting brackets for pipe and frame mounting Ø 30-50 mm, incl. nuts and washers	
MZ8120-A12		2 mounting brackets for pipe and frame mounting Ø 40-64 mm, incl. nuts and washers	

Order code (example): C14100 – A1056 – F1 – H21 – Y12 – T200 – K1010

<sup>1</sup> possible for piezoresistive nominal ranges up to 100 bar only

<sup>2</sup> for nominal ranges: 1...40 bar and 1...16 bar abs at a Turndown of ≤ 3.75:1 only

<sup>3</sup> requires front cover of stainless steel

<sup>4</sup> not possible with thin film sensors (order code A3163 and A3166)