

Pressure transmitter PASCAL CV, for diaphragm seal operation, hygienic Type series CV311.-.-K



Features

- Modular pressure transmitter
Output signal:
 - 4...20 mA
 - HART® protocol (rev. 6), option
 - PROFIBUS PA, option
- Function modules
 - Multifunctional display with 5-segment digital display and bar graph
 - Switching module with 2 floating channels, maximum 0.5 A switching current, electrically isolated at all sides, without additional auxiliary power
- Function module replacement on site without recalibration "plug and measure"
- Hygienic design according to EHEDG, FDA and GMP recommendations
- Material and surface quality according to the hygienic requirements
- Limits of measuring range 0...80 mbar to 0...40 bar
- Accuracy $\leq 0.15\%$
- Turndown 5:1
- Degree of protection IP 66, piezoresistive measuring cell directly aerated



Application area

- Pharmaceutical industry
- Food industry
- Biotechnology

Application

The modular pressure transmitter PASCAL CV is suited for measuring the relative and absolute pressure of gases, vapors and liquids. The use of a HYGIENIC process adapter allows the device to be deployed in a variety of processes.

Options

- Labom REconnect quick coupling device for easy and safe separation and connection of diaphragm seal systems; Type series MK1000, see data sheet D6-022
- Approvals/Certificates
 - Explosion protection (ATEX/IECEx/UKEX) for gases and dust
 - Material certificate as per EN 10204-3.1
 - Calibration certificate as per EN 10204-3.1
 - Classification per SIL2
- As per UKCA regulations
- Hygienic design
- Degree of protection IP 69K

Basic module

4...20 mA

PROFIBUS PA



Function modules

Switching module

HART®-module

Display module



Technical data

Measuring ranges

Up to a turndown of 5:1 the measuring span can be freely selected.

Nominal range	Measuring span		Overload capacity **	Lower measuring range limit ***
	min.	max.		
0...0.4 bar *	80 mbar	0.8 bar	1 bar rel.	600 mbar abs
0...1 bar *	0.2 bar	2 bar	3 bar rel.	100 mbar abs
0...4 bar rel. *	0.8 bar	5 bar	10 bar rel.	100 mbar abs
0...16 bar rel. *	3.2 bar	17 bar	60 bar rel.	100 mbar abs
0...40 bar rel. *	8 bar	41 bar	100 bar rel.	100 mbar abs
0...4 bar abs	0.8 bar abs.	4 bar abs.	10 bar abs.	30 mbar abs
0...16 bar abs	3.2 bar abs.	16 bar abs.	60 bar abs.	30 mbar abs

* Short term or sporadic measurement in vacuum range permitted up to lower measuring limit. Lower range value up to -1 bar rel. adjustable.

** High overload protected designs are available upon request.

*** Vacuum-proof designs are available upon request.

Constructional design / case

Design:	Two-chamber case design with screw cap. Minimum case volume, excellent moisture and condensate protection
Material:	Stainless steel mat.-no. 1.4301 (304)
Degree of protection:	per EN 60529 <ul style="list-style-type: none"> ■ IP 66 ■ optional: IP 69K
Climatic category:	4K4H per EN 60721 3-4
Pressure compensation:	PTFE filter system
Window:	Non splintering plastic: Makrolon
Case seal:	O-ring: NBR
El. connection:	Screw terminal 1 mm ²
Cable gland:	<ul style="list-style-type: none"> ■ Cable gland M16, material: PA ■ Circular connector M12
	Further details see order code and upon request.
Weight:	Standard device without diaphragm seal and function modules approx. 0.65 kg

case design:

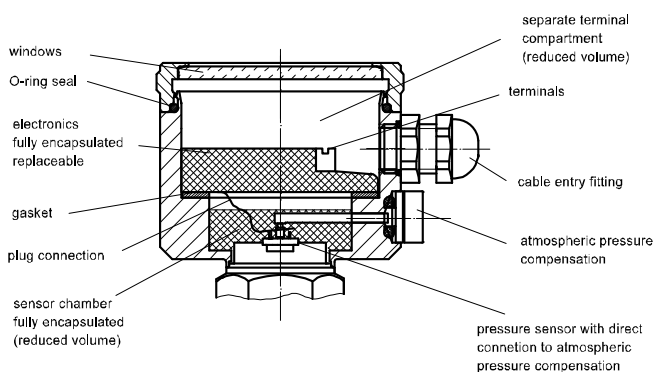

Process connection

Design:	See order details
---------	-------------------

Material wetted parts

Material:	Stainless steel mat. no. 1.4435 (316L/316)
Gasket:	EPDM-FDA listed (in case of flush mounted diaphragm with O-ring)

Measuring system

Sensor:	Piezoresistive measuring element
System filling:	Synthetic oil FD1, free of silicone, FDA compliant

Hygienic design

The surface roughness of the wetted parts made of stainless steel are executed according to EHEDG Doc.8 and ASME BPE SF3. In case of choosing the additional feature HY, we guarantee the following surface roughness values:

Diaphragm foil:	Ra ≤ 0.38 µm
Laser welds:	Ra ≤ 0.76 µm
Turned parts:	Ra ≤ 0.76 µm

Further versions of hygienic design upon request.

Accuracy

General:	
Limit point setting:	per DIN 16086
Reference conditions:	per EN 60770-1
Linearity errors:	≤ 0.15 % of span TD 5:1 no modification
Hysteresis:	≤ 0.05 % of nominal range
Repeatability:	≤ 0.05 % of nominal range
Calibration position:	Vertical mounting position

Influence of mounting position:	≤ 3.5 mbar
Long-term drift: (EN 60770-1)	≤ 0.1 % / year of nominal range
Temperature influence case:	Lower range value / upper range value Range 0...60 °C: ± 0.15 % / 10K of nominal range Range < 0 °C, > 60 °C: ± 0.2 % / 10K of nominal range

Process connection
depending on design

Diaphragm seal	Zero point error
DN 25/1"	4.8 mbar/10K
DN 32/1 1/2"	2.3 mbar/10K
DN 40	1.6 mbar/10K
DN 50/2"	0.6 mbar/10K
HYGIENIC G1A	1 mbar/10K

The specify zero error for the process connection is a guide value for a standard design. We can provide a detailed system calculation upon request. Systems with reduced diaphragm seal errors are also available.

Output

General:

Delay time:	approx. 160 ms
Measuring cycle:	6 measurements / second
Measuring range setting:	Turndown 5:1
<u>Basic module: 4...20 mA</u>	
Signal:	4...20 mA, 2-wire
Current range:	3.8...20.8 mA
Current limitation:	approx. 22 mA
Alarm state:	< 3.6 mA, optional > 21 mA
Damping:	0...120 seconds
Load R:	$R \leq (U-12V DC)/0.022 A [\Omega]$ U = supply voltage

Basic module: PROFIBUS PA

Signal:	digital per IEC 61158-2
Protocol:	EN 50170-PROFIBUS PA, Profile 3.0
Sensor address:	0...126 (126 = factory setting)
Power consumption:	constantly 11 mA
Alarm current I _{FDE} :	2 mA
Damping:	0...300 seconds
Parameterisation:	SIMATIC PDM

Supply voltage

Basic module:	4...20 mA	PROFIBUS PA
<u>Standard design:</u>		
Functional range:	12...40 V DC	9...32 V DC
<u>Ex-design:</u>		
Functional range:	12...30 V DC	9...17.5 V DC

Temperature ranges

Ambient:	-20...85 °C
Media:	depending on design, see order code
Storage:	-40...85 °C

Note safety values as per examination certificate!

Tests and certificates

Interference emission:	per EN 55011
Noise immunity:	per EN 61326-1 *, NAMUR NE21 *

* Devices with cable gland or switching outputs might suffer from a short-time measuring deviation if exposed to strong electromagnetic fields (EN 61000-4-3).

Ex approvals

ATEX:	TÜV 04 ATEX 2387 X Ex II 1/2G Ex ia IIC T4/T5/T6 Ga/Gb Ex II 2G Ex ia IIC T4/T5/T6 Gb Ex II 2D Ex ia IIIC Txx °C Db
UKEX:	CML 21UKEX21176X Ex II 1/2G Ex ia IIC T4/T5/T6 Ga/Gb Ex II 2G Ex ia IIC T4/T5/T6 Gb Ex II 2D Ex ia IIIC Txx °C Db

For detailed information see Ex Safety Instruction XA_015 and XA_020.

SIL2:	Functional safety per EN 61508, Classification per SIL2. For basic module 4...20 mA, switching module, display module and HART® module TÜV-Reg.-No. 44 799 13190201
-------	---

Function modules

Display module (multifunctional display) optional

pluggable with automatic module detection - plug and measure -

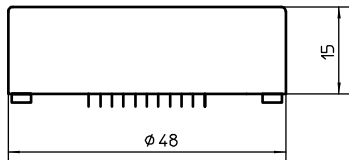
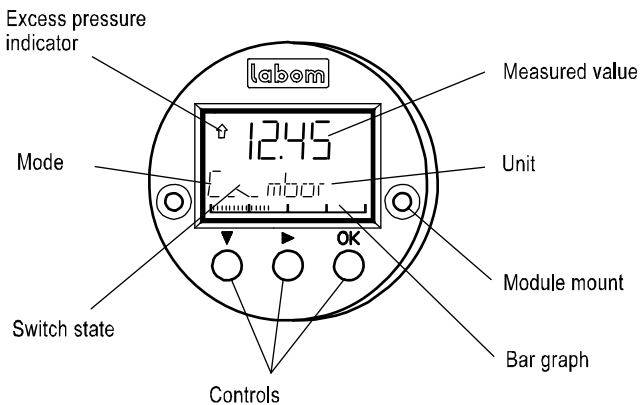

- Module housing made of ABS, encapsulated electronics unit
- Many operating mode menus
- 5-segment pressure read-out with unit
- Read-out display
 - pressure (standard)
 - percent *
 - current *
 - sensor temperature
- Bar graph 36 segment suitable 0...100 %
- Loop test (current sensing function) 3.55...22 mA *
- Alarm indicator on display
- Switching function indicator*

* not with basic module PROFIBUS PA

Details of the operator menu see parameterisation.

HART® module (for basic module 4...20 mA) optional

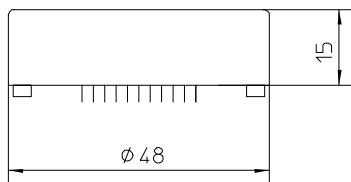
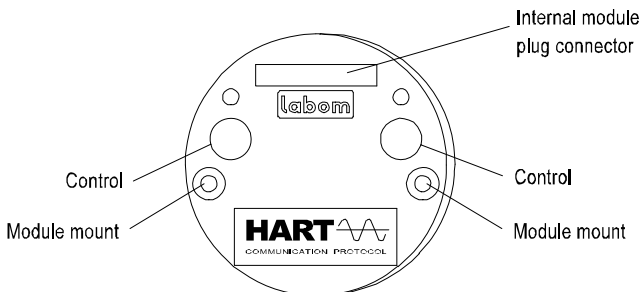

- HART®-protocol, revision 6.5
- Response characteristic FSK
- Load with HART® communication
 - with Hart® modem 230...500 Ω
 - with Hart® communicator 230...1100 Ω
- Parameterisation via
 - operating elements
 - HART® communication
- PDM 6.0
- AMS
- 375 Field Communicator

Switching module, (not with basic module PROFIBUS PA) optional

pluggable with automatic module detection - plug and measure -

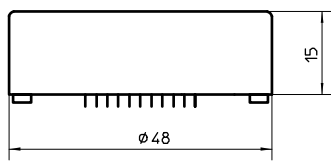
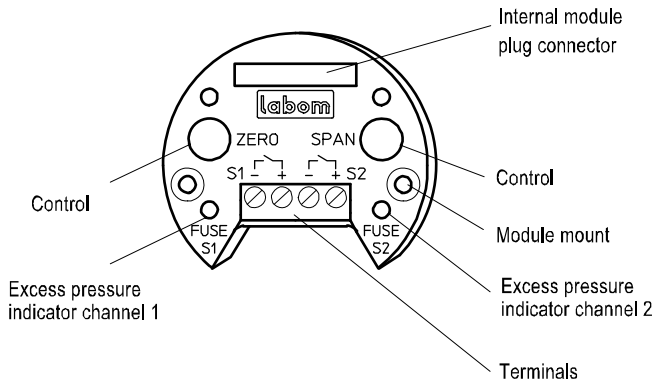

- No additional auxiliary power required
- Module housing made of ABS, encapsulated electronics unit
- Electronic switch for 2 limit values, voltage free, short-circuit-proof
- Switching capacity 30 V DC / 0.5 A ($R_i < 0.3 \Omega$)
- Indicator: red LED, indicates overload or short-circuit
- Cut-out fuse protects against overload / short-circuit with automatic reset
- Switch points: 0.0 - 100.0% adjustable, Standard: 50.0%
- Switching function: maker or breaker, adjustable, Standard: breaker
- Contact open when device switched off
- Hysteresis: 0.0...100 % adjustable, Standard 0.1 %
 - falling or rising, adjustable, standard: falling
- Switching rate: 6 Hz
- Electrically isolated to all sides, Insulation voltage: 500 V, 2.5 kV/2 sec.
- Electrical connection: terminal blocks 1 mm²

Hysteresis functions

-falling hysteresis-

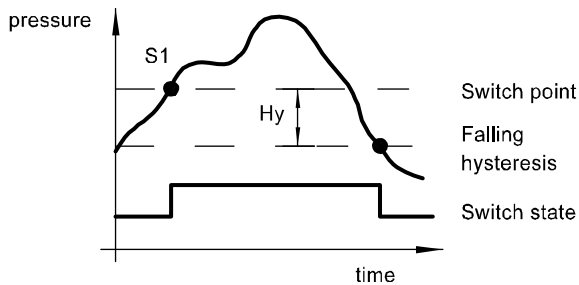

-rising hysteresis-

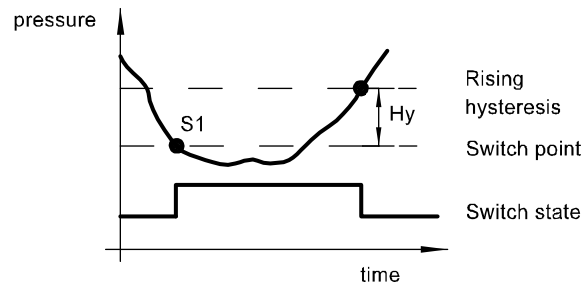

Description of switching module and HART® module upon request.

Parameterisation

The module selected determines which parameters can be set

operating menus	display of display module	parameter		basic module: 4...20 mA				basic module: PROFIBUS PA		
		variability	standard	BM	SM	AM	HM PDM AMS 475	BM	AM	PDM
zero point *	RANGE/Zero	see instrument ranges	0 bar	x	x	x	x	-	-	x
measuring span *	RANGE/Span	see instrument ranges	nominal range	x	x	x	x	-	-	x
damping	DAMP	4...20 mA: 0...120 sec. Profibus: 0...300 sec.	0 sec.	w	-	x	x	-	-	x
min-max-value	HI/LO	pressure and temperature reset-table	-	-	-	x	x	-	x	x
characteristic	FUNC	linear, table	linear	w	-	x	x	-	-	x
pressure unit	UNIT	bar, mbar, kPa, MPa, mmH2O, mH2O, kg/cm2, PSI	bar	w	-	x	x	-	w	x
loop test	LOOP	3.55...22 mA	-	-	-	x	x	-	-	-
alarm state	ALARM	< 3.6 mA, > 21 mA	< 3.6 mA	w	-	x	x	-	-	-
current trimming	I-CAL	-2...5 %	-	-	-	x	x	-	-	-
pressure trimming	P-CAL	zero point: -50...50 % v.N span: -10...10 % v.N	-	-	-	x	x	x	x	x
table function	TABLE	2...31 points of table	0% = 4 mA 100% = 20 mA	w	-	x	x	-	-	-
system info	INFO	software, serial number, revision level	-	-	-	x	x	-	x	x
factory data reset	RESET	-	-	-	-	x	x	-	x	x
BUS adress	BUS	0...126	126	-	-	-	-	w	x	x
switch points	SWCH1(2)	0...100 % of nominal range	50 %	-	x	x	x	-	-	-
hysteresis	SWCH1(2)/Hyst.	0...100 % of nominal range	0,1 % hyster. falling	-	w	x	x	-	-	-
switch function	SWCH1(2)/SwTyp	breaker, maker	breaker	-	w	x	x	-	-	-
HART® address	HART/Adres	0...63	0	-	-	x	x	-	-	-
HART® current	HART/CUrr	fixed/float	float	-	-	x	x	-	-	-
write protection	-	ON/OFF	OFF	x	x	x	x	x	x	x

x = configurable

w = factor setting

* = calibrated measuring span for devices with PROFIBUS PA basic module

DM = display module

BM = basic module

SM = switching module

HM = HART-module

PDM = Siemens Process Device Manager

AMS = Asset Management Solutions

475 = Emerson Handheld Communicator

Connection diagram

Basic module: 4...20 mA / PROFIBUS PA

Internal terminals with cable gland design

Circular connector ¹

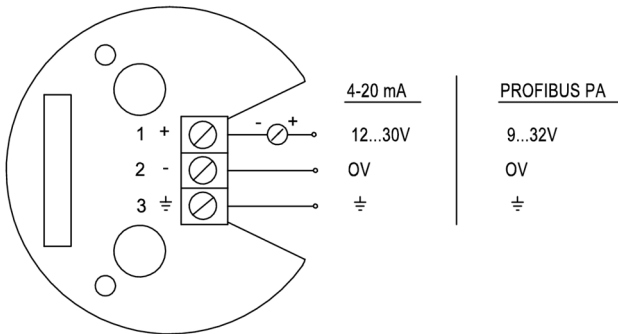

Switching module: (only with basic module 4...20 mA)

Circular connector ¹

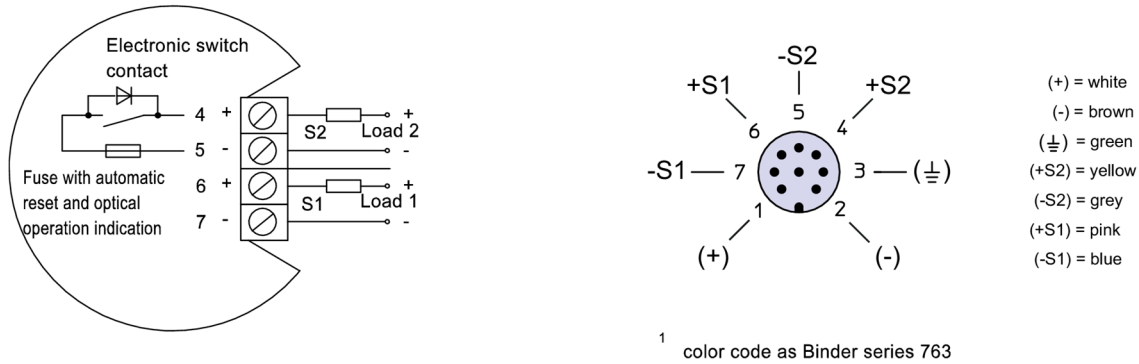

Dimensions

Case

housing design type 17

-basic module: 4...20 mA
with one function module (optional)
-basic module: PROFIBUS PA

housing design type 25

-basic module: PROFIBUS PA
with display module (optional)

housing design type 32

-basic module: 4...20 mA
with two function modules (optional)

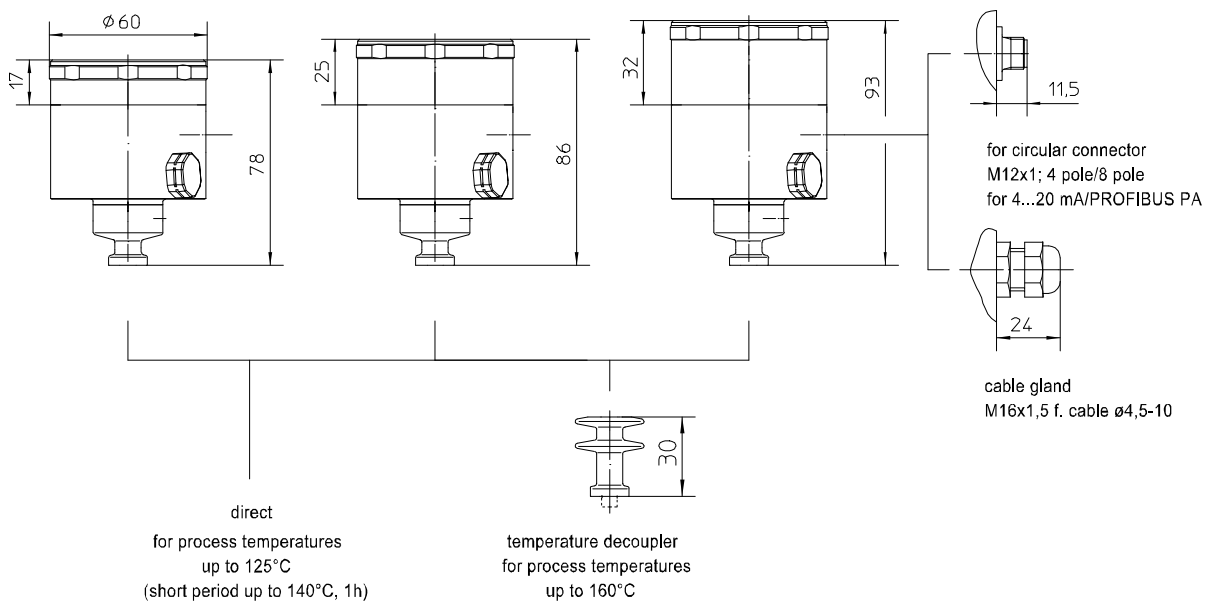

All dimensions are in mm

Process connection

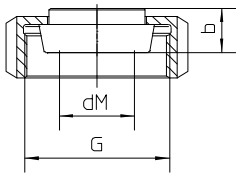

sanitary connection with coupling nut per DIN 11851

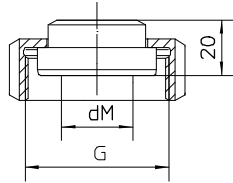

aseptic screw joint collar connection with union nut per DIN 11864-1

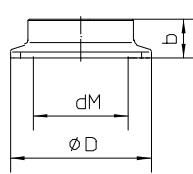

clamp connection per DIN 32676/ISO 2852

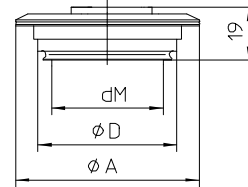

VARIVENT® connection for VARINLINE® case

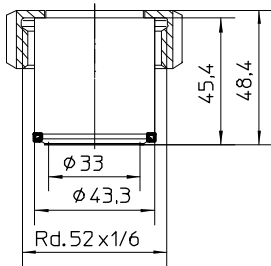

HYGENIC-Tubus *
Ø43,3 with screwing
DN25/PN40

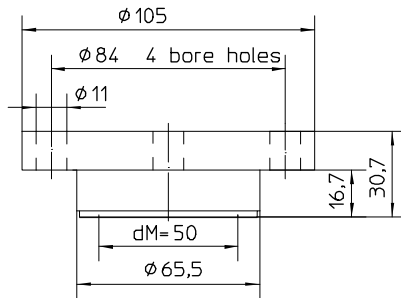

DRD-connection DN50 PN40 *

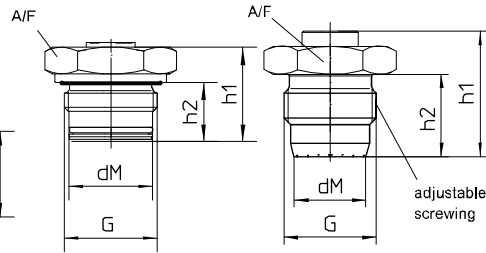

Screw-in thread *
with o-ring-gasket
and additionally gasket
per DIN EN ISO 1179-2
model E (DIN 3852)

HYGENIC-screw-in thread *
no gasket
tightening torque
20 Nm, max. nominal pressure 10 bar
50 Nm, max. nominal pressure 50 bar

* weld-in adapter
see data-sheet D6-037

All dimensions are in mm

Sanitary pipe connection with union nut per DIN 11851

DN	PN	dM	b	G
25	40	27	16	Rd.52x1/6"
32	40	34	16	Rd.58x1/6"
40	40	40	16	Rd.65x1/6"
50	25	51	17	Rd.78x1/6"

Aseptic screw joint collar connection with union nut per DIN 11864-1

DN	PN	dM	G
25	40	24	Rd.52x1/6"
32	40	30	Rd.58x1/6"
40	40	34	Rd.65x1/6"
50	25	48	Rd.78x1/6"

Clamp connection per DIN 32676 model A (metric) for pipes per EN 10357 (DIN 11850)

DN	PN	dM	b	D
25	25	22.6	14	50.5
32	25	27	12	50.5
40	25	34	12	50.5
50	16	46	14	64

Clamp connection per DIN 32676 model B (OD, ISO) for pipes per DIN EN ISO 1127

DN	PN	dM	b	D
26.9	25	22.6	14	50.5
33.7	25	27	12	50.5
42.4	25	34	12	64
48.3	16	40	14	64

Clamp connection per DIN 32676 model C (Tri-Clamp) for pipes per ASME BPE

DN	PN	dM	b	D
3/4"	25	15.5	15	25
1"	25	22.6	14	50.5
1 1/2"	25	34	12	50.5
2"	16	46	14	64

Clamp connection per ISO 2852 for pipes per ISO 2037

DN	PN	dM	b	D
25	16	22.6	14	50.5
38	16	34	12	50.5
51	16	46	14	64

VARIVENT® connection for VARINLINE® access unit

Connection	PN	dM	A	D
Form F	25	40	66	50
Form N	25	58	84	68

HYGENIC screw-in thread, gasket without elastomer

G	PN (bar)	dM	h1	h2	SW
G1 A	50	24	45	28.5	36

Screw-in thread with O ring gasket





G	PN (bar)	dM	h1	h2	SW
G1/2 A	200	15.5	33	20.5	27
G1 A	50	24	33	20.5	41

Order details

Pressure transmitter PASCAL CV for diaphragm seal operation, hygienic Type series CV311.-.-K.

Order details PASCAL CV311.-.-K.					
CV311.	Pressure transmitter PASCAL CV for diaphragm seal operation, hygienic				
0	design	without			
1		Ex-protection, marking as follows			
	nominal range	nominal range	overload limit		
A1051		0.4 bar	1 bar		
A1053		1 bar	3 bar		
A1056		4 bar	10 bar		
A1059		16 bar	60 bar		
A1061		40 bar	100 bar		
B1056		4 bar abs	10 bar		
B1059		16 bar abs	60 bar		
F10		measuring range	0...nominal range, unit: bar (standard)		
F11	0...nominal range, unit: mbar				
F22	0...nominal range, unit: kPa				
F23	0...nominal range, unit: MPa				
F30	0...nominal range, unit: mmH2O				
F32	0...nominal range, unit: mH2O				
F41	0...nominal range, unit: kg/cm ²				
F50	0...nominal range, unit: PSI				
F80	set from ... to ... unit (please fill in details) not with PROFIBUS PA				
F81	adjusted and calibrated from to, unit (pls.fill in details), see below for calibration report				
H11 . .	output signal	4...20 mA, rising characteristic (standard)			
H15 . .		20...4 mA, falling characteristic			
H21 . .		4...20 mA, with HART® function module			
0		setting ¹	damping	0.0 sec. (standard)	
1				0.0...120.0 sec., set to...(please fill in)	
0			alarm state	< 3.6 mA (Standard)	
1				> 21 mA	
H41		PROFIBUS PA, IEC 61158-2, Profil 3.0			
M1		display module	without		
M2			multifunctional display with 5-position digital display and bargraph, pluggable		
N10	switching module ^{2,3} (not with PROFIBUS PA) (not with Ex-protection)	without switching module			
N5 .		switching module with 2 contacts, pluggable	switching capacity 30 V DC / 0.5 A		
0		setting ¹	standard		
1		at the factory: specify as required			
T30	electrical connection	circular connector	M12x1 (4-pin)		
T31			M12x1 (8-pin, required for switching module)		
T32			M12x1 (5-pin)		
T20		cable gland M16x1.5	polyamide black		
T21			brass-nickel plated		
T22			stainless steel		

K1085	design	for processing temperature up to 125 °C (short term up to 140 °C)		
K2085		for processing temperature up to 160 °C (with temperature decoupler)		
K102	process connection ⁴ material: ASTM 316L	sanitary pipe connection with union nut per DIN 11851 ^{5,6}	DN 25	
K103			DN 32	
K104			DN 40	
K105			DN 50	
K162			aseptic screw joint collar connection with union nut per DIN 11864-1 ⁵	DN 25
K163		DN 32		
K165		DN 40		
K166		DN 50		
K124		Clamp connection per ISO 2852 for pipes per ISO 2037 ^{5,6}	DN 25 (1")	
K126			DN 38 (1 1/2")	
K127			DN 51 (2")	
K144		Clamp connection per DIN 32676, model A (metric) for pipes per EN 10357 (DIN 11850) ^{5,6}	DN 25	
K146			DN 32	
K147			DN 40	
K148			DN 50	
K213			Clamp connection per DIN 32676, model B (OD, ISO) for pipes per EN ISO 1127 ^{5,6}	DN 26.9
K214		DN 33.7		
K215		DN 42.4		
K216		DN 48.3		
K136		Clamp connection per DIN 32676, model C (Tri-Clamp) for pipes per ASME BPE ^{5,6}	DN 1"	
K137			DN 1 1/2"	
K138			DN 2"	
K152		VARIVENT® connection ^{5,6}	Form F (D=50) for VARINLINE® access unit	
K153			Form N (D=68) for VARINLINE® access unit	
K172		HYGIENIC Tubus	Ø 43,3 mm with screwing DN 25/PN 40	
K185		DRD connection	nominal with DN 50 / nominal pressure PN 40	
K195		screw-in thread	G 1 A with O ring gasket ⁷	
K80			HYGIENIC G1A, elsatomer-free sealing (1.4436)	
		surface roughness	standard	
HY		(wetted parts)	Hygienic version as per EHEDG Doc.8 and ASME BPE SF3	

Additional features (to be indicated if required)			
S68	Ex marking ²	ATEX	 II 2G Ex ia IIC T4/T5/T6 Gb, II 2 D Ex ia IIIC Txx°C Db
S66			 II 1/2G Ex ia IIC T4/T5/T6 Ga/Gb
S88		UKEX	 II 2G Ex ia IIC T4/T5/T6 Gb, II 2 D Ex ia IIIC Txx°C Db
S86			 II 1/2G Ex ia IIC T4/T5/T6 Ga/Gb
T4	degree of protection	IP 69K	
Z61	PROFIBUS PA	factory setting, please specify	
Z62		measuring-point number/identification max. 32 characters, please specify	
Z63		measuring-point text max. 32 characters, please specify	
W4035	process connection (diaphragm seal) electropolished		
W1020	material certificate as per EN 10204-3.1, wetted parts (stainless steel)		
W1201	calibration certificate as per EN 10204-3.1, 5 measuring points		
W2602	functional safety as per EN 61508, classification per SIL ^{2,3}		
W2660	as per UKCA regulations		

Order code (example): CV3110 - A1051 - F11 - H1100 - M2 - N10 - T20 - K1085 - K103 -

¹ extensive parameterization is possible when the transmitter is operated with the display module, the HART® function module or the PROFIBUS module.

² Ex-design not possible with switching module.

³ not with PROFIBUS PA

⁴ other process connections als well as aseptic designs upon request.

⁵ EHEDG certified only in connection with hygienic design (order code option HY)

⁶ EHEDG certificate valid only if gaskets are used that are listed in the "EHEDG position paper"

⁷ hygienic design not possible