

**Pressure transmitters
a/w process flange MDF
Model EDN.316**

all st. steel housing of wetted parts
with Declaration of Conformity, CE

General features

- Pressure Transmitters assembled with various flanges called by MDF
- Pressure range from 0...1.6 bar to 0...250 bar
- Assembled with process flange according to the standard
- Ingress production IP65
- Wetted parts of stainless steel, 316L

Application area

- Petroleum and chemical industry
- Water supply and water treatment plant
- Hydraulic and pneumatic control systems
- Hydro and nuclear power application
- General process industry

General specification

Pressure ranges

0...1.6 bar to 0...250 bar

Accuracy

± 0.5% FS

included Linearity+Hysteresis+Repeatability

Overpressure

1.3 X pressure range

Output type

4...20mA, 2-wire system

0...10V, 3-wire system

0...5V, 3-wire system

1...5V, 3-wire system

Power supply

Ref. power: DC 20V

Available power: DC 12...28V

Response time

≤ 5ms

Isolation

> 100MΩ at 100 VDC

Temperature range

Operating: -20...100 °C

-40...120 °C / option

Temperature compensating range:

0...60 °C

-10...80 °C / option

Ambient: -20...100 °C

Storage: -20...100 °C



Pressure transmitter series EDN.316

Thermal error

Zero thermal error: ±0.75%FS @ 25 °C, typical

Span thermal error: ±0.75%FS @ 25 °C, typical

Materials

Wetted parts: St. steel 316L

Body: St. steel 316L

Electrical connection

DIN43650 A

M12 Plug

Cable type

Others on request

Process connection

According to DIN 1092-1

According to ASME B16.5

According to JIS

Protection

IP65 with plug DIN 43650A

Weight

Approx. 140g and additionally depends on each flanges

Option

High temperature adapter

up to 200 °C / up to 300 °C

Technical specifications

Input pressure range

Norminal pressure:
0...1.6 bar up to 0...250 bar

Permissible static pressure:
1.3 x pressure range

Output signal / Supply

Current:
2-wire 4...20mA Vs=12...28 VDC

Voltage:
3-wire 0...10V, 0...5V, 1...5V Vs=12...28 VDC

Performance

¹Accuracy: $\leq \pm 0.5\% \text{FSO @ } 25^\circ\text{C}$
¹ accuracy according to IEC 60770 - limit point adjustment including non-linearity, hysteresis as well as repeatability

Permissible load / R_L
Current: 2-wire, $R_L \text{ max} = [(V_s - V_s \text{ min}) / 0.02 \text{A}] \Omega$
Voltage: 3-wire, $R_L \text{ min} = 10 \text{k}\Omega$

Influence effects:
Supply: 0.05%FSO/10V
Longterm stability: $\leq \pm 0.5\% \text{FS} / \text{year}$
Response time: <5ms

Thermal effects (Offset and Span) / Permissible temperatures

FS thermal error: $\pm 0.75\% \text{FS @ } 25^\circ\text{C}$, typical
Zero thermal error: $\pm 0.75\% \text{FS @ } 25^\circ\text{C}$, typical
Operating temperature: -20...100 °C
Compensated teperature: 0...60 °C

Electrical protection

Electromagnetic compatibility:
Emission and immunity according to
EN 61326-2-3:20B CCISPR II Group 1, Class A
EN IEC 61000-3-2:2019

Insulation: the transmitter is grounded via the process connection

Mechanical stability

Vibration: No change at 10 g RMS (20...2000) Hz
Shock: 0.1 g (1m/s) Max.

Materials

Pressure port: stainless steel 316L
Housing / body: stainless steel 304
Sensor diaphragm: stainless steel 316L
Wetted parts: stainless steel 316L

Miscellaneous

Current consumption
Signal output current max. 25mA

Current
4...20mA, 2-wire system
Signal output voltage max. 7mA

Voltage:
0...10V, 3-wire system
0...5V, 3-wire system
1...5V, 3-wire system

Ingress protection: IP65

EMC Test report for CE conformance

- EN 61326-2-3:2013 / Class A
- EN 61326-2-3: 2013 / IEC 61326-1:2012

Ordering information

Model code

EDN.316 · [] · [] · B [] · []

Output signal

O1	4...20mA / 2-wire system
O2	0...10V / 3-wire system
O3	0...5V / 3-wire system
O4	1...5V / 3-wire system

Electrical connection

D	DIN 43650 A
B	Binder plug
C	2m cable
H	General head

Pressure range code, unit bar

Code	Range
R26	0...1.6
R28	0...2.5
R30	0...4
R32	0...6
R33	0...10
R35	0...16
R37	0...25
R39	0...40
R41	0...60
R43	0...100
R45	0...160
R47	0...250
RYY	Others on request

Process connection

Flange standard DIN 1092-1	See tables on page 4
Flange standard ASME B16.5	
Flange standard JIS	

Option code

Code	Description
RS	Restrictor screw in socket hole
NO	"USE NO OIL" for Oxygen application
AD	Adapter
CD2	Cooling device up to 200°C
CD3	Cooling device up to 300°C
TP	St. steel tag plate, 60 x 20 x 0.5t
DMCC	Manufacture calibration certificate
KC	KOLAS Ilac-MRA calibration certificate
CC	Certificate of conformance / origin

How to order

EDN.316.O1.D.BR35 aw MBF, DN25 PN160 according to DIN 1092-1

EDN.316, 4...20mA, DIN 43650, 0...16 bar aw MBF, DN25 PN160 according to DIN 1092-1,

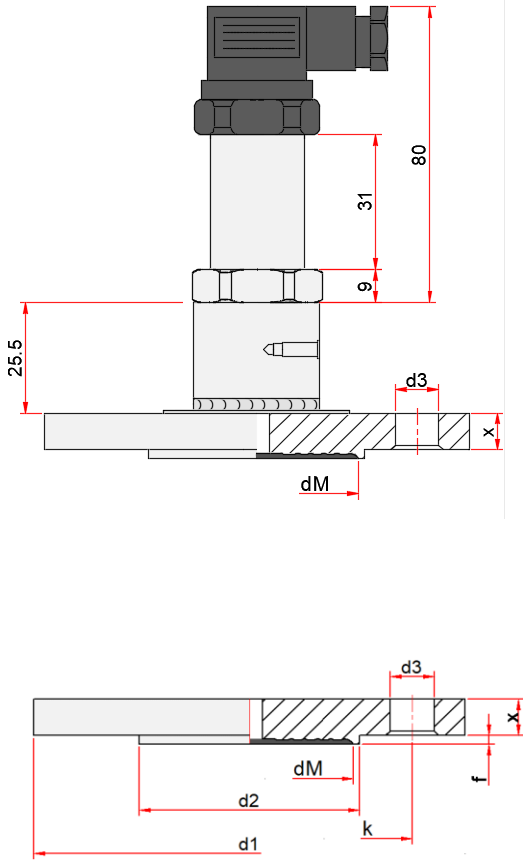

DIN 1092-1									
DN	PN	d1	d2	d3	dM	f	k	x	
25	10/40	115	68	Ø 14 x 4	28	2	85	18	
	63/100	140		Ø 18 x 4			100	24	
	160			Ø 22 x 4			105	28	
	250			Ø 26 x 4			115	34	
	320			Ø 26 x 4			130	38	
	400			Ø 26 x 4			130	38	
32	10/40	140	78	Ø 18 x 4	34	3	100	18	
40	10/40	150	88	Ø 18 x 4	38		110	18	
	50	25/40	165	102	Ø 22 x 4		57	125	20
		63	180		Ø 26 x 4			135	26
		100	195		Ø 26 x 8			145	28
		160	200		Ø 26 x 8			150	38
		250	210		Ø 30 x 8	160		42	
400		235	Ø 30 x 8		180	52			
65	25/40	185	122	Ø 18 X 8	72	3	145	22	
80	10/16	200	138	Ø 18 X 8	84		160	20	
	25/40			Ø 22 X 8			170	28	
	63	71		Ø 26 X 8			180	32	
	100	75		Ø 30 X 8			180	36	
	160	79		Ø 30 X 8			200	46	
	250	89		Ø 30 X 8		200	46		
100	10/16	63	158	Ø 18 X 8	84	3	180	20	
	25/40	67	162	Ø 22 X 8			190	24	
	63	73		Ø 26 X 8			200	30	
	100	79		Ø 30 X 8			210	36	
	160	83		Ø 30 X 8			235	40	
	250	97		Ø 33 X 8			235	54	

ASME B16.5								
NPS	Class	d1	d2	d3	dM	f	k	x
1"	150	108	50.8	Ø 15.7 x 4	28	1.6	79.2	14.2
	300	124		Ø 19.1 x 4			88.9	17.5
	400/600	124		Ø 25.4 x 4		6.4	101.6	34.8
	900/1500	149.4					108	41.5
	2500	158.8					108	41.5
1 1/2"	150	127	73.2	Ø 15.7 x 4	38	1.6	98.6	17.5
	300	155.4		Ø 22.4 x 4			114.3	20.6
	400/600	155.4		Ø 22.4 x 4		6.4	114.3	28.8
2"	150	152.4	91.9	Ø 19.1 x 4	57	1.6	120.7	19.1
	300	165.1		Ø 19.1 x 8			127	22.4
	400/600	165.1		Ø 25.4 x 8		6.4	165.1	44.5
	900/1500	215.9					171.5	57.2
	2500	235					171.5	57.2
3"	150	190.5	127	Ø 19.1 x 8	84	1.6	152.4	23.9
	300	209.6		Ø 22.4 x 8			168.1	28.4
	400/600	209.6		Ø 25.4 x 8		6.4	190.5	44.5
	900	241.3					203.2	54.2
	1500	266.7					228.6	72.9
	2500	304.8					228.6	72.9
4"	150	228.6	157.2	Ø 19.1 x 8	84	1.6	190.5	23.9
	300	254		Ø 22.4 x 8			200.2	31.8
	400			Ø 25.4 x 8		6.4	215.9	44.5
	600	273.1					234.9	50.8
	900	292.1					241.3	60.2
	1500	311.2					241.3	60.2

Pin assignment

DIN 43650A connector according to DIN EN 175301-803A

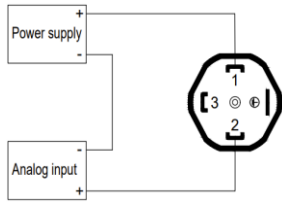

2-wire / current

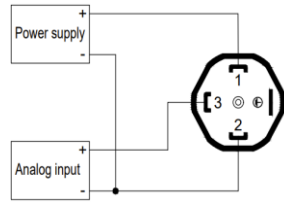

3-wire / voltage

Pin No.	2-Wire	3-Wire
1	+Vcc	+Vcc
2	Output(mA)	GND
3		Output(VDC)

M12 x 1, 5-pin / male

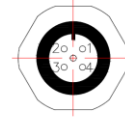

Pin No.	2-Wire	3-Wire
1	+Vcc	+Vcc
2	Output(mA)	GND
3		Output(VDC)
4		

Connection wiring diagram

Flying leads with 2m cable

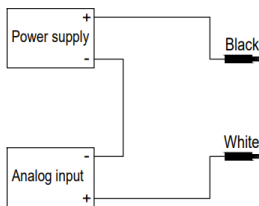

2-wire / current

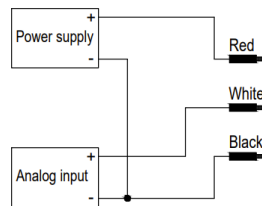

3-wire / voltage

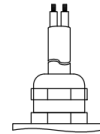

	2-Wire	3-Wire
White	Output(mA)	Output(VDC)
Red		+Vcc
Black	+Vcc	GND